



DEKLARACJA WŁAŚCIWOŚCI UŻYTKOWYCH



DoP: 0142

dla FUR plastic anchor dla concrete and masonry (łączniki tworzywowe do zastosowania w betonie i w murach) – PL

1. Niepowtarzalny kod identyfikacyjny typu wyrobu: **DoP: 0142**
2. Zamierzone zastosowanie: **Do zastosowania w systemach fasadowych, lub podwieszania elementów, które wpływają na stabilność systemu, zobacz dodatek, w szczególności aneksy B 1 do B 4**
3. Producent: **fischerwerke GmbH & Co. KG, Klaus-Fischer-Straße 1, 72178 Waldachtal, Niemcy**
4. Upoważniony przedstawiciel: --
5. System(-y) oceny i weryfikacji stałości właściwości użytkowych: **2+**
6. Europejski dokument oceny: **ETAG 020, 2012-03**

Europejska ocena techniczna: **ETA-13/0235; 2018-05-31**

Jednostka dsoceny technicznej: **ETA-Danmark A/S**

Jednostka lub jednostki notyfikowane: **1343 – MPA Darmstadt**

7. Deklarowane właściwości użytkowe:

Wytrzymałość mechaniczna i stabilność osadzenia (BWR 1), Bezpieczeństwo i dostępność (BWR 4)

- **Nośność charakterystyczna na wrywanie i ścinanie: Zobacz dodatek, w szczególności aneksy C 1 do C 2**
- **Nośność charakterystyczna na moment zginający: Zobacz dodatek, w szczególności aneksy C 1**
- **Przemieszczenia pod wpływem obciążeń ścinających i wrywających: Zobacz dodatek, w szczególności aneks C 1**
- **Odstępy kotew i wymiary złącza: Zobacz dodatek, w szczególności aneksy B 2 do B 3**

Ochrona przeciwpożarowa (BWR 2)

- **Reakcja na ogień: spełniają wymagania dla klasy A1**
- **Odporność na działanie ognia: Zobacz dodatek, w szczególności aneks C 1**

8. Odpowiednia dokumentacja techniczna lub specjalna dokumentacja techniczna: ---

Właściwości użytkowe określonego powyżej wyrobu są zgodne z zestawem deklarowanych właściwości użytkowych. Niniejsza deklaracja właściwości użytkowych wydana zostaje zgodnie z rozporządzeniem (UE) nr 305/2011 na wyłączną odpowiedzialność producenta określonego powyżej.

W imieniu producenta podpisał(-a):

Andreas Bucher, Dipl.-Ing.

Wolfgang Hengesbach, Dipl.-Ing., Dipl.-Wirtsch.-Ing.

Tumlingen, 2018-06-06

- Niniejsza Deklaracja Właściwości Użytkowych została przygotowana w różnych językach. W razie wątpliwości w interpretacji, wersja angielska jest zawsze miarodajna.
- Dodatek zawierający dobrowolne i uzupełniające informacje w języku angielskim, (neutralne językowo) a wykraczające poza wymagania prawne.

II SPECIFIC PART OF THE EUROPEAN TECHNICAL ASSESSMENT

1 Technical description of product and intended use

Technical description of the product

Fischer FUR 10 is a plastic anchor consisting of a plastic sleeve made of polyamide and an accompanying specific screw of galvanised steel or galvanized steel with an additional Duplex-coating or of stainless steel.

The plastic sleeve is expanded by screwing in the specific screw which presses the sleeve against the wall of the drilled hole.

The installed anchor is shown in Annex 1

2 Specification of the intended use in accordance with the applicable EAD

The performances given in Section 3 are only valid if the anchor is used in compliance with the specifications and conditions given in Annex B.

The verifications and assessment methods on which this European Technical Assessment is based lead to the assumption of a working life of the anchors of at least 50 years.

The indications given on the working life cannot be interpreted as a guarantee given by the producer, but are to be regarded only as a means for choosing the right products in relation to the expected economically reasonable working life of the works.

3 Performance of the product and references to the methods used for its assessment

3.1 Mechanical resistance and stability (BWR 1)

The essential characteristics regarding mechanical resistance and stability are included under the Basic Works Requirement Safety in use

3.2 Safety in case of fire (BWR 2)

Reaction to fire Anchorages satisfy requirements for Class A 1
Resistance to fire See Annex C 1

3.3 Safety and accessibility (BWR 4)

Characteristic resistance for tension and shear loads, see Annexes C 1, C 2
Characteristic resistance for bending moments, see Annex C 1
Displacements under shear and tension loads, see Annex C 1
Anchor distances and dimensions of members, see Annex B 2 and B3.

3.4 General aspects

The verification of durability is part of testing the essential characteristics.

Durability is only ensured if the specifications of intended use according to Annex B are taken into account.

4 Attestation and verification of constancy of performance (AVCP)

4.1 AVCP system

In accordance with guideline for European technical approval ETAG 020, March 2012 used as European Assessment Document (EAD) according to Article 66 Paragraph 3 of Regulation (EU) No 305/2011 the applicable European legal act is: 97/463/EC. The system to be applied is 2+.

fischer frame fixing FUR

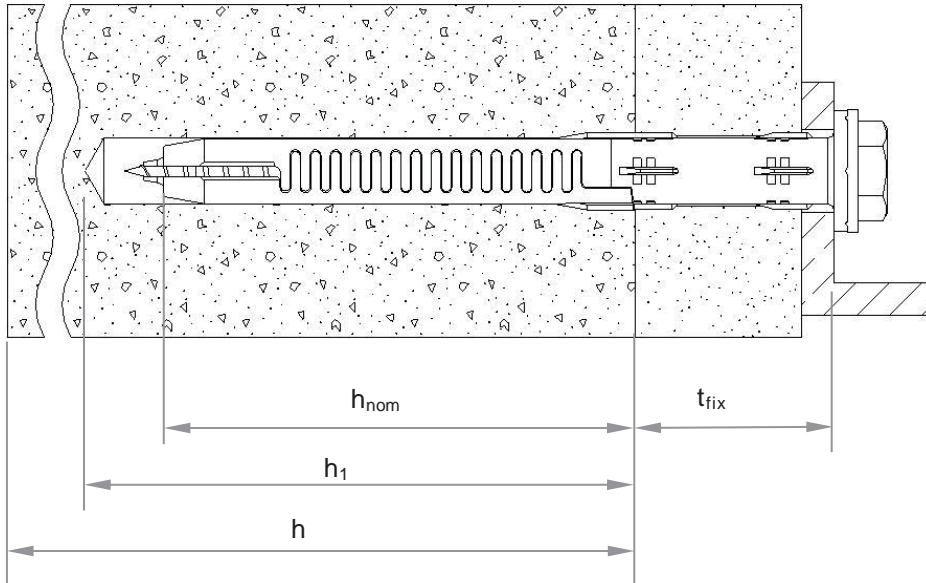

Intended Use

Fixing in concrete and different kinds of masonry

Legend

- h_{nom} = overall plastic anchor embedment depth in the base material
- h_1 = depth of drill hole to deepest point
- h = thickness of member (wall)
- t_{fix} = thickness of fixture and / or non-load bearing layer

Figures not to scale

fischer long shaft fixing FUR

Annex A 1

Product description
Installed anchor

FUR

Anchor sleeve
countersunk version:

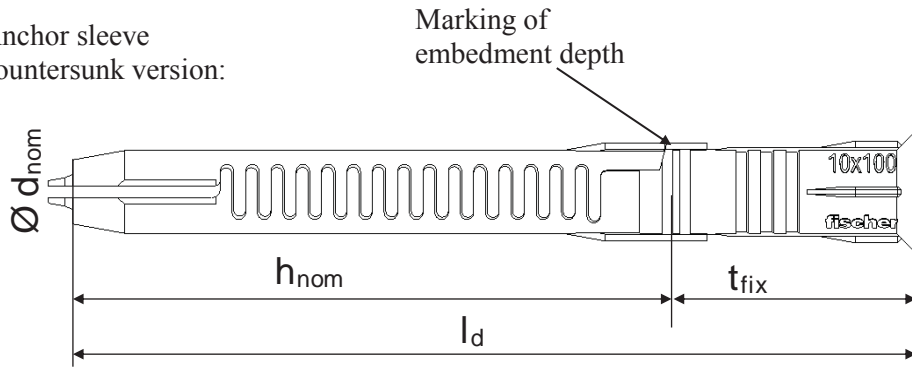

Marking:
Brand
Anchor type
Size
e.g. FUR 10x100

flat-collar version:

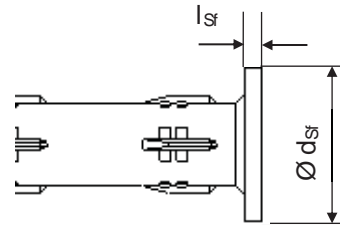

Special screw:

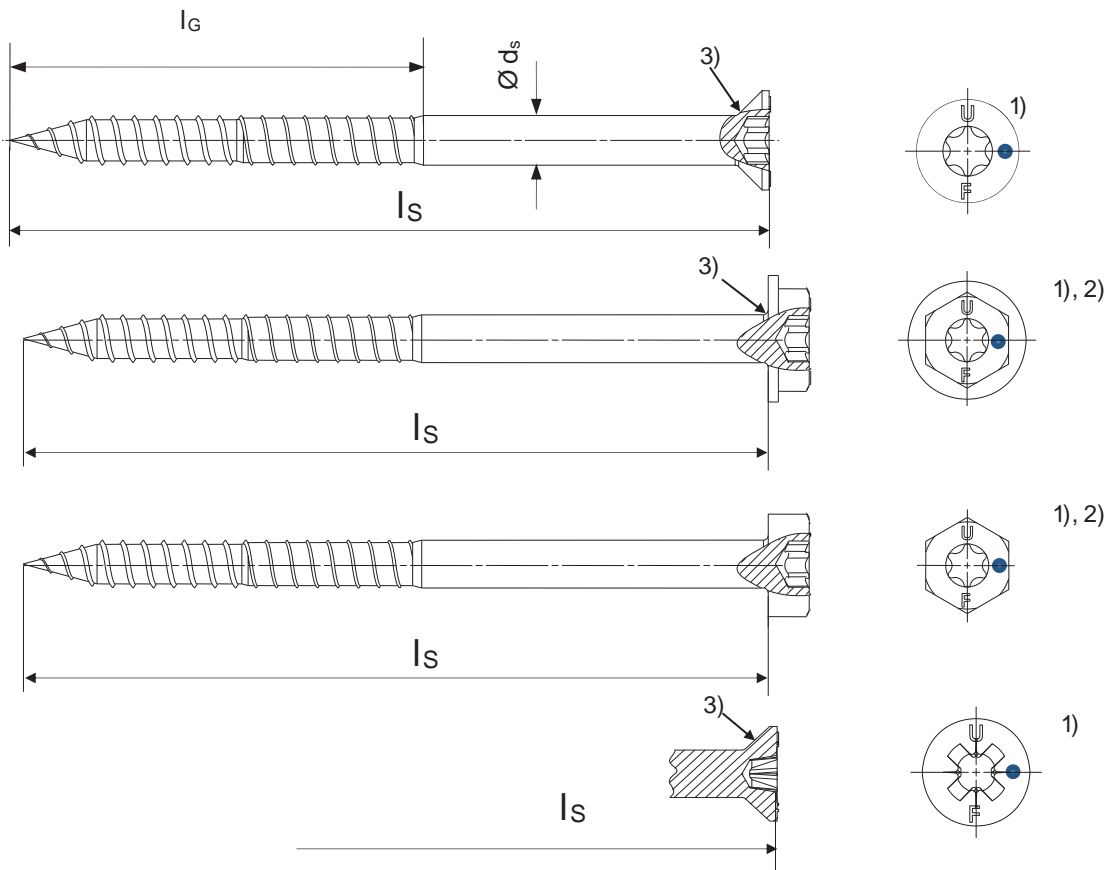

- 1) Additional marking of the special stainless-steel screw: „A4“.
- 2) Internal driving feature for Torx bit is optional for hexagonal head
- 3) Optional additional version with underhead ribs

Figures not to scale

fischer long shaft fixing FUR

Annex A 2

Product description
Anchor types / special screws

Table A3.1: Dimensions [mm]

Anchor type	Anchor sleeve [mm]						Special screw [mm]		
	h_{nom}	$\varnothing d_{nom}$	t_{fix}	l_d	$l_{sf}^{2)}$	$\varnothing d_{sf}$	$\varnothing d_s$	l_G	l_s
FUR 10	70	10	≥ 1	71-360	2,2	18,5	7,0	≥ 77	$\geq 78^{1)}$

1) To ensure that the screw penetrates the anchor sleeve, l_s must be $l_d + l_{sf}^{2)} + 7$ mm

2) Only valid for flat collar version

Table A3.2: Materials

Name	Material
Anchor sleeve	Polyamide, PA6, colour grey
Special screw	- Steel gvz A2G or A2F acc. to EN ISO 4042:2001 or - Steel gvz A2G or A2F acc. to EN ISO 4042:2001+ Duplex-coating type Delta-Seal in three layers (total layer thickness $\geq 6 \mu\text{m}$) or - Stainless steel acc. to EN 10 088-3:2014, e.g. 1.4401, 1.4571, 1.4578, 1.4362

fischer long shaft fixing FUR

Annex A 3

Product description
Dimension / Materials

Specifications of intended use

Anchorage subject to:

- Static and quasi-static loads.
- Multiple fixing of non-structural applications.

Base materials:

- Reinforced or unreinforced normal weight concrete with strength classes \geq C12/15 (use category “a”), according to EN 206-1:2000, Annex C1.
- Solid brick masonry (use category “b”), according to Annex C2.
Note: The characteristic resistance is also valid for larger brick sizes and higher compressive strengths of the masonry unit.
- Hollow brick masonry (use category “c”), according to Annex C2.
- Mortar strength class of the masonry \geq M2,5 according to EN 998-2:2010.
- For other base materials of the use categories “a”, “b” or “c” the characteristic resistance of the anchor may be determined by job site tests according to ETAG 020, Annex B, Edition March 2012.

Temperature Range:

FUR 10

- c: - 20 °C to 50 °C (max. short term temperature + 50 °C and max long term temperature + 30 °C)
- b: - 20 °C to 80 °C (max. short term temperature + 80 °C and max long term temperature + 50 °C)

Use conditions (Environmental conditions):

- Structures subject to dry internal conditions (zinc coated steel, stainless steel).
- The specific screw made of galvanised steel or galvanised steel with an additional Duplex-coating may also be used in structures subject to external atmospheric exposure, if the area of the head of the screw is protected against moisture and driving rain after mounting of the fixing unit in this way, that intrusion of moisture into the anchor shaft is prevented. Therefore there shall be an external cladding or a ventilated rainscreen mounted in front of the head of the screw and the head of the screw itself shall be coated with a soft plastic, permanently elastic bitumen-oil-combination coating (e.g. undercoating or body cavity protection for cars).
- Structures subject to external atmospheric exposure (including industrial and marine environment) and to permanently damp internal condition, if no particular aggressive conditions exist (stainless steel).
Note: Particular aggressive conditions are e.g. permanent, alternating immersion in seawater or the splash zone of seawater, chloride atmosphere of indoor swimming pools or atmosphere with extreme chemical pollution (e.g. in desulphurization plants or road tunnels where de-icing materials are used).

Design:

- The anchorages are to be designed in accordance with the ETAG 020, Annex C under the responsibility of an engineer experienced in anchorages and masonry work.
- Verifiable calculation notes and drawings shall be prepared taking account of the loads to be anchored, the nature and strength of the base materials and the dimensions of the anchorage members as well as of the relevant tolerances. The position of the anchor is indicated on the design drawings.
- Fasteners are only to be used for multiple use for non-structural application, according to ETAG 020, Edition March 2012.

Installation:

- Hole drilling by the drilling method according to Annex C1 and C2 for use categories “b” and “c”.
- Anchor installation carried out by appropriately qualified personnel and under the supervision of the person responsible for technical matters of the site.
- Installation temperature FUR 10: **- 20 °C to + 40 °C**
- Exposure to UV due to solar radiation of the not protected anchor \leq 6 weeks.

fischer long shaft fixing FUR	Annex B 1
Intended use Specifications	

Table B1.1: Installation parameters

Anchor type		FUR 10
Drill hole diameter	$d_0 =$ [mm]	10
Cutting diameter of drill bit	$d_{cut} \leq$ [mm]	10,45
Depth of drill hole to deepest point ¹⁾	$h_1 \geq$ [mm]	85
Overall plastic anchor embedment depth in the base material ^{1) 2)}	$h_{nom} \geq$ [mm]	70
Diameter of clearance hole in the fixture	$d_f \leq$ [mm]	12,5

1) See Annex 1

2) If the embedment depth is higher than h_{nom} given in Table B1.1 (only for hollow and perforated masonry), job site tests have to be carried out according to ETAG 020, Annex B.

Table B1.2: Minimum thickness of member, edge distance and spacing in concrete

Anchor type		Minimum thickness of member h_{min} [mm]	Characteristic edge distance $c_{cr,N}$ [mm]	Characteristic spacing $s_{cr,N}$ [mm]	Minimum allowable spacing and edge distances ¹⁾ [mm]
FUR 10	Concrete \geq C16/20	110	100	80	$s_{min} = 50$ for $c \geq 100$ $c_{min} = 50$ for $s \geq 150$
	Concrete C12/15		140	90	$s_{min} = 70$ for $c \geq 140$ $c_{min} = 70$ for $s \geq 210$

1) Intermediate values by linear interpolation

FUR 10: In case a fixing point consists of more than 1 anchor with spacing of $s \leq s_{cr,N}$, this fixing point is considered as a group with a max. characteristic resistance $N_{Rk,p}$ acc. to Table 6.

For $s > s_{cr,N}$, the anchors are always considered as single anchors, each with a characteristic resistance $N_{Rk,p}$ acc. to Table 6.

Scheme of distance and spacing in concrete

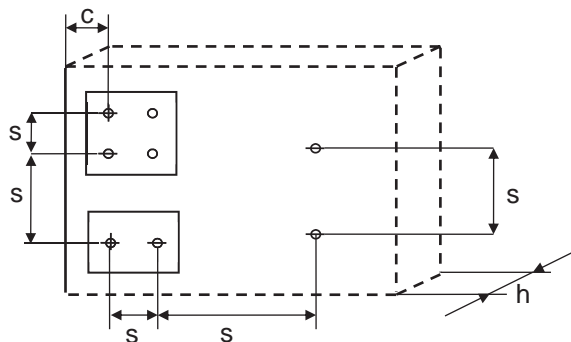

Figures not to scale

fischer long shaft fixing FUR

Annex B 2

Intended use

Installation parameters, minimum thickness, edge distances and spacings

Table B2.1: Minimum distances and dimensions in masonry

Anchor type			FUR 10
Minimum thickness of member	h_{min}	[mm]	110
Single anchor			
Minimum allowable spacing	s_{min}	[mm]	250
Minimum allowable edge distance	c_{min}	[mm]	100
Anchor Group			
Minimum allowable spacing perpendicular to free edge	$s_{1,min}$	[mm]	100
Minimum allowable spacing parallel to free edge	$s_{2,min}$	[mm]	100
Minimum allowable edge distance	c_{min}	[mm]	100

Scheme of distance and spacing in masonry

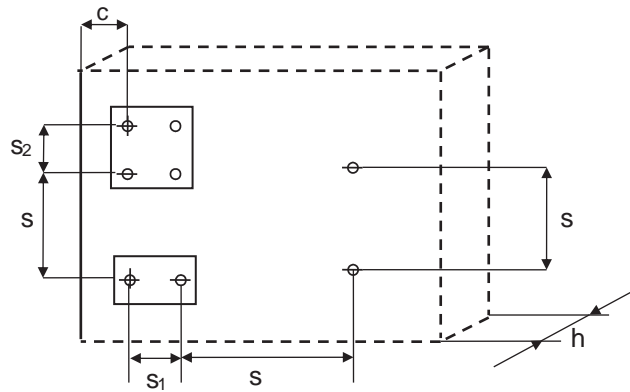

Figures not to scale

fischer long shaft fixing FUR

Annex B 3

Intended use

Minimum distances and dimensions in masonry

Installation Instructions (the following pictures show fixing through timber parts)

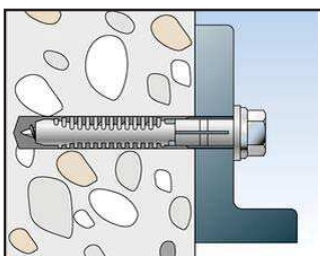
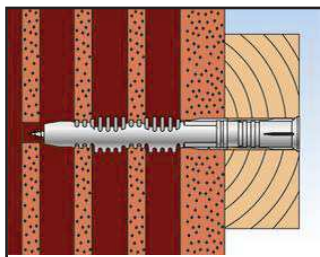
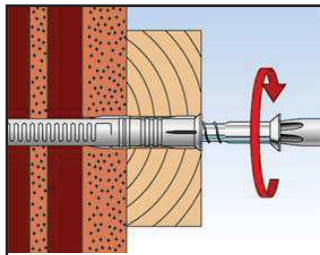
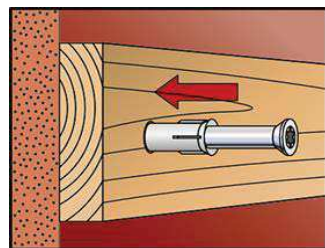
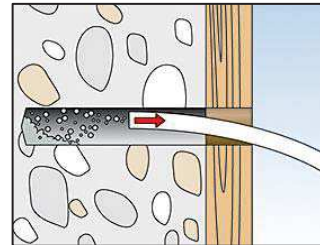
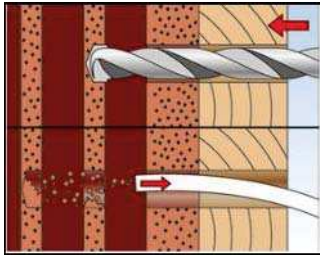

1. Drill the bore hole acc. to Table B1.1 using the drill method described in the corresponding Annex C.

2. Remove dust from borehole (masonry and concrete).

3. Insert anchor (screw and plug) by using a hammer until the collar of the plastic sleeve is flush with the surface of the fixture.

4. The screw is screwed-in until the head of the screw touches the sleeve. The anchor is correctly mounted, when the head of the screw fits tight on the surface and cannot be screwed-in any further.

5. Correctly installed anchor in hollow masonry.

6. Correctly installed anchor in concrete.

Figures not to scale

fischer long shaft fixing FUR

Annex B 4

Intended use
Installation instructions

Table C1.1: Characteristic bending resistance of the screw in concrete and masonry

Anchor type		FUR 10	
Material		galvanised steel	stainless steel
Characteristic bending resistance	$M_{Rk,s}$ [Nm]	17,7	17,1
Partial safety factor	γ_{Ms} ¹⁾	1,25	1,29

¹⁾ In absence of other national regulations

Table C1.2: Characteristic resistance of the screw for use in concrete

Failure of expansion element (special screw)		FUR 10	
		galvanized steel	stainless steel
Characteristic tension resistance	$N_{Rk,s}$ [kN]	18,7	18,1
Partial safety factor	γ_{Ms} ¹⁾	1,50	1,55
Characteristic shear resistance	$V_{Rk,s}$ [kN]	9,4	9,0
Partial safety factor	γ_{Ms} ¹⁾	1,25	1,29

¹⁾ In absence of other national regulations

Table C1.3: Characteristic resistance for use in concrete (use categorie “a”)

Pull-out failure (plastic sleeve)		FUR 10
Concrete \geq C12/15		
Characteristic resistance	$N_{Rk,p}$ [kN]	4,5
Partial safety factor	γ_{Mc} ¹⁾	1,8

¹⁾ In absence of other national regulations

Table C1.4: Displacements under tension und shear loading in concrete¹⁾, masonry¹⁾

Anchor type	Tension load			Shear load	
	F ²⁾ [kN]	δ_{NO} [mm]	$\delta_{N\infty}$ [mm]	δ_{v0} [mm]	$\delta_{v\infty}$ [mm]
FUR 10	1,8	0,62	1,24	3,39	5,09

1) Valid for all ranges of temperatures

2) Intermediate values by linear interpolation

Table C1.5: Values under fire exposure in concrete C20/25 to C50/60 in any load direction no permanent centric tension load and without lever arm

Anchor type	Fire resistance class	F ¹⁾
FUR 10	R 90	$\leq 0,8$ kN

¹⁾ $F_{Rk} / (\gamma_m \times \gamma_F)$

fischer long shaft fixing FUR

Annex C 1

Performances

Characteristic resistance and characteristic bending resistance of the screw
Characteristic resistance for use in concrete and values under fire exposure

Table C2.1: FUR 10 characteristic resistance F_{RK} in [kN] in solid and hollow masonry (use category “b” and “c”)

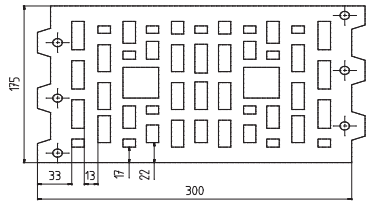
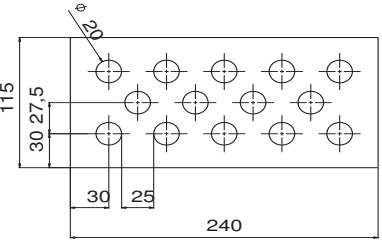
Base material [Supplier Title]	Use Cat.	Geometry and min. DF or min. size (L x W x H) and drilling method [mm]	min. compressive strength f_b [N/mm ²] / bulk density $\geq \rho$ [kg/dm ³]	Characteristic resistance F_{RK} FUR 10 [kN]
				30/50 °C 50/80 °C
Clay solid brick Mz , e.g. acc. to EN 771-1:2011 e.g. Schlagmann	b	NF (240x113x71) by hammer drilling	12/1,8	3,0
			10/1,8	2,5
			8/1,8	2,0
Calcium silicate solid brick KS, acc. to EN 771-2:2011, e.g. KS Wemding	b	NF (240x113x71) by hammer drilling	20/1,8	2,5
			10/1,8	2,0
			8/1,8	1,5
		(500x175x235) by hammer drilling	12/1,8	3,5
			10/1,8	3,0
			8/1,8	2,5
Lightweight solid brick, Vbl acc. to EN 771-3:2011, e.g. KLB	b	(250x240x245) by hammer drilling	8/1,6	3,0
			6/1,6	2,0
Clay brick Form B, HLz acc. to EN 771-1:2011	c	 by rotary drilling	20/1,4	2,0
			16/1,4	1,7
			12/1,4	1,3
			10/1,4	1,0
Hollow calcium silicate brick KSL , acc. to EN 771- 2:2011, e.g. KS Wemding	c	 2 DF (240x115x113) by hammer drilling	16/1,6	2,5
			12/1,6	2,0
			10/1,6	1,5
Partial safety factor ¹⁾			γ_{Mm}	2,5

¹⁾ In absence of other national regulations

Figures not to scale

fischer long shaft fixing FUR

Annex C 2

Performances

Characteristic resistance in masonry (cat. “b” and “c”)